

# Flowmeter

Original operating manual

Series  
DFM 165 – 350



---

Version BA-2016.08.09 EN  
Print-No. 300 458  
TR MA DE Rev002

ASV Stübbe GmbH & Co. KG  
Hollwieser Straße 5  
32602 Vlotho  
Germany  
Phone: +49 (0) 5733-799-0  
Fax: +49 (0) 5733-799-5000  
E-mail: [contact@asv-stuebbe.de](mailto:contact@asv-stuebbe.de)  
Internet: [www.asv-stuebbe.com](http://www.asv-stuebbe.com)



We reserve the right to make technical changes.  
Read carefully before use.  
Save for future use.

## Table of contents

<b>1 About this document</b>	3
1.1 Target groups	3
1.2 Other applicable documents	3
1.3 Warnings and symbols	3
<b>2 General safety instructions</b>	4
2.1 Intended use	4
2.2 General safety instructions	4
2.2.1 Obligations of the operating company	4
2.2.2 Obligations of personnel	4
2.3 Specific hazards	4
2.3.1 Hazardous media	4
<b>3 Layout and Function</b>	5
3.1 Marking	5
3.1.1 Name plate	5
3.2 Description	5
3.3 Layout	5
<b>4 Transport, Storage and Disposal</b>	6
4.1 Unpacking and inspection on delivery	6
4.2 Transportation	6
4.3 Storage	6
4.4 Disposal	6
<b>5 Installation and connection</b>	7
5.1 Check operating conditions	7
5.2 Planning pipelines	7
5.2.1 Specify pipes and fittings	7
5.2.2 Providing safety and control devices (recommended)	7
5.3 Install device	8
5.3.2 Connection with union nut and insert	8
5.3.3 Connection with flange	8
5.3.4 If necessary: Attach special scale	8
5.4 Performing the hydrostatic test	8
<b>6 Operation</b>	9
6.1 Commissioning	9
6.2 Read measurement	9
<b>7 Maintenance</b>	10
7.1 Servicing	10
7.2 Maintenance	10
7.2.1 Removing fitting	10
7.3 Replacement parts and return	10
<b>8 Troubleshooting</b>	11
8.1 Clean measuring tube and float	11
<b>9 Appendix</b>	12
9.1 Technical specifications	12
9.1.1 Mechanical specifications	12

9.1.2 Dimensions	12
9.2 Tightening torques	12
9.3 Accessories	12

## List of figures

Fig. 1 Name plate (example)	5
Fig. 2 Layout	5

## List of tables

Tab. 1 Other application documents, purpose and where found	3
Tab. 2 Warnings and symbols	3
Tab. 3 Servicing activities	10
Tab. 4 Troubleshooting	11
Tab. 5 Mechanical specifications	12
Tab. 6 Tightening torques	12
Tab. 7 Accessories	12

# 1 About this document

This manual

- is part of the equipment
- applies to all series referred to
- describes safe and proper operation during all operating phases

## 1.1 Target groups



### Operating company

- Responsibilities:
  - Always keep this manual accessible where the device is used on the system.
  - Ensure that employees read and observe this document, particularly the safety instructions and warnings, and the documents which also apply.
  - Observe any additional country-specific rules and regulations that relate to the system.

### Qualified personnel, fitter







- Mechanics qualification:
  - Qualified employees with additional training for fitting the respective pipework.
- Electrical qualification:
  - Qualified electrician
- Transport qualification:
  - Qualified transport specialist
- Responsibility:
  - Read, observe and follow this manual and the other applicable documents, especially all safety instructions and warnings.

## 1.2 Other applicable documents

<p><b>Resistance lists</b> Resistance of materials used to chemicals</p>  <p><a href="http://www.asv-stuebbe.de/pdf_resistance/300051.pdf">www.asv-stuebbe.de/pdf_resistance/300051.pdf</a></p>
<p> <b>Data sheet</b> Technical specifications, conditions of operation</p> <p><a href="http://www.asv-stuebbe.de/pdf_datasheets/300464.pdf">www.asv-stuebbe.de/pdf_datasheets/300464.pdf</a></p>
<p><b>CE declaration of conformity</b> Conformity with standards</p>  <p><a href="http://www.asv-stuebbe.de/pdf_DOC/300168.pdf">www.asv-stuebbe.de/pdf_DOC/300168.pdf</a></p>

Tab. 1 Other application documents, purpose and where found

## 1.3 Warnings and symbols

Symbol	Meaning
	<ul style="list-style-type: none"> <li>• Immediate acute risk</li> <li>• Death, serious bodily harm</li> </ul>
	<ul style="list-style-type: none"> <li>• Potentially acute risk</li> <li>• Death, serious bodily harm</li> </ul>
	<ul style="list-style-type: none"> <li>• Potentially hazardous situation</li> <li>• Minor injury</li> </ul>
	<ul style="list-style-type: none"> <li>• Potentially hazardous situation</li> <li>• Material damage</li> </ul>
	Safety warning sign ► Take note of all information highlighted by the safety warning sign and follow the instructions to avoid injury or death.
	Instruction
1. , 2. , ...	Multiple-step instructions
✓	Precondition
→	Cross reference
	Information, notes

Tab. 2 Warnings and symbols

## 2 General safety instructions

 The manufacturer accepts no liability for damages caused by disregarding any of the documentation.

### 2.1 Intended use

The device measures the flow of a liquid or gaseous medium.

- Device must only be used for measuring the flow in liquid or gaseous media.
  - Measuring tubes made of PVC may not be used for gaseous media (danger of splintering)
- Only use the device with suitable media (→ resistance lists).
- Adhere to the operating limits (→ Data sheet).

### 2.2 General safety instructions

 Observe the following regulations before carrying out any work.

#### 2.2.1 Obligations of the operating company

##### Safety-conscious operation

- Only operate the device if it is in perfect technical condition and only use it as intended, staying aware of safety and risks, and in adherence to the instructions in this manual.
- Ensure that the following safety aspects are observed and monitored:
  - Intended use
  - Statutory or other safety and accident-prevention regulations
  - Safety regulations governing the handling of hazardous substances
  - Applicable standards and guidelines in the country where the pump is operated
- Make personal protective equipment available.

##### Qualified personnel

- Make sure all personnel tasked with work on the device have read and understood this manual and all other applicable documents, especially the safety, maintenance and repair information, before they start any work.
- Organize responsibilities, areas of competence and the supervision of personnel.
- The following work should be carried out by specialist technicians only:
  - Installation, repair and maintenance work
  - Work on the electrical system
- Make sure that trainee personnel only work on the device under supervision of specialist technicians.

#### 2.2.2 Obligations of personnel

Only complete work on the device if the following requirements are met:

- System is empty
- System has been flushed
- System is depressurized
- System has cooled down
- System is secured against being switched back on again
- Do not make any modifications to the device.

### 2.3 Specific hazards

#### 2.3.1 Hazardous media

- When handling hazardous media, observe the safety regulations for the handling of hazardous substances.
- Use personal protective equipment when carrying out any work on the device.
- Collect leaking pumped liquid and residues in a safe manner and dispose of in accordance with environmental regulations.

### 3 Layout and Function

#### 3.1 Marking

##### 3.1.1 Name plate

 The name plate is found on the packing box.

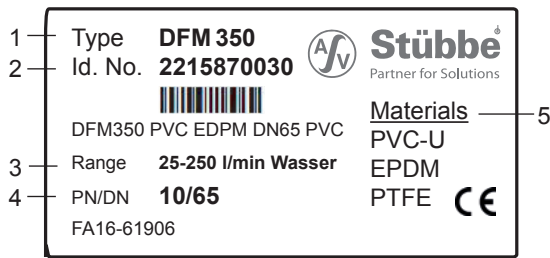

Fig. 1 Name plate (example)

- 1 Type
- 2 ID number
- 3 Measurement range
- 4 Nominal pressure [bar] / Nominal diameter [mm]
- 5 Materials (body, ball, other seals/gaskets)

#### 3.2 Description

The device measures the flow of a liquid or gaseous medium. The medium flows through the flowmeter vertically from bottom to top. The float is lifted by the flow forces. On the upper reading edge (largest diameter), the flow quantity (in volume or mass) can be read on the measuring tube scale.

The displayed value only applies for the medium and medium temperature for which the device has been calibrated.

#### 3.3 Layout

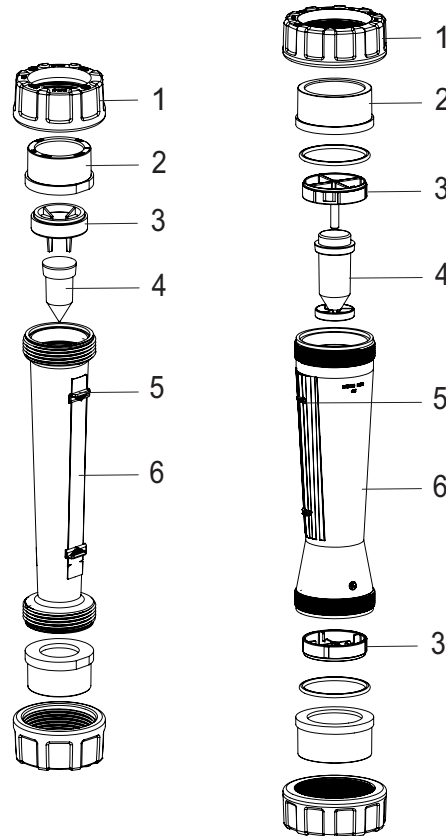

Fig. 2 Layout

- 1 Union nut
- 2 Union end
- 3 Union end (stop)
- 4 Float
- 5 Setpoint indicator
- 6 Measuring tube

## 4 Transport, Storage and Disposal

### 4.1 Unpacking and inspection on delivery

1. Unpack the device when received and inspect it for transport damage and completeness.
2. Check that the material specifications on the name plate (see packing box) and order/sizing data match.
3. Report any transport damage to the manufacturer immediately.
4. If fitted immediately: Dispose of packaging material according to local regulations.
  - If fitted at a later point: leave device in its original packaging.

### 4.2 Transportation

- ▶ Device should preferably be transported in the original packaging.

### 4.3 Storage

---

#### NOTE

---

#### Material damage due to inappropriate storage!

- ▶ Store the device properly.
1. Make sure the storage room meets the following conditions:
    - Dry
    - Frost-free
    - Vibration-free
    - Not in direct sunlight
    - Storage temperature +10 °C to +60 °C
  2. Device should preferably be stored in the original packaging.

### 4.4 Disposal

- 
 Plastic parts can be contaminated by poisonous or radioactive media to such an extent that cleaning will not be sufficient.

**WARNING**

#### Risk of poisoning and environmental damage from medium.

- ▶ Use personal protective equipment when carrying out any work on the device.
- ▶ Prior to the disposal of the device: Neutralize residues of medium in the device.

- 
1. Remove battery and dispose of in accordance with local regulations.
  2. Remove electronic parts and dispose of in accordance with local regulations.
  3. Dispose of plastic parts in accordance with local regulations.

## 5 Installation and connection

### 5.1 Check operating conditions

#### **⚠ WARNING**

##### Splintering measuring tube!

- ▶ Do not use measuring tube made of PVC for gaseous media.

1. Ensure the required operating conditions are met:
  - Resistance of body and seal material to the medium (→ resistance lists).
  - Media temperature (→ Data sheet).
  - Operating pressure (→ Data sheet).
2. Consult with the manufacturer regarding any other use of the device.

### 5.2 Planning pipelines

#### 5.2.1 Specify pipes and fittings

1. Ensure installation position:
  - vertical
  - Direction of flow from bottom to top
  - Device is freely accessible from all sides
2. Ensure pipe connection without tension.
  - If necessary, equip with expansion shanks or pipe compensators
3. Straight pipe lengths before and after device (recommended to avoid vibration of the float)
  - DN = DN device
  - Length > 5–7 x DN device
  - Length > 10 x DN device for large differences between nominal diameters between pipe and device
4. If necessary:
  - For gaseous media, equip with vent valve at highest point of inlet and outlet pipe
  - For condensing gaseous, equip with vent valve at lowest point of inlet and outlet pipe
5. Allocate control valves after device.
6. Allocate throttle valves before or after the device.
  - For gasses, only after the device (to prevent vibrations of the float)

#### 5.2.2 Providing safety and control devices (recommended)

##### Avoid contamination

1. Install filter into supply line.
2. Install a differential pressure gauge to monitor contamination.

#### Make provisions for isolating and shutting off the pipes

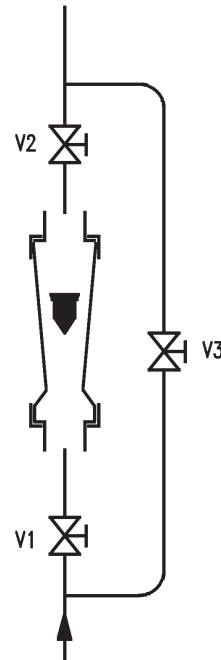

 For maintenance and repair work.

1. Provide shut-off devices (V1, V2) in the inlet and outlet line.
2. If removal of the device during operation is necessary: Install bypass line (V3).

### 5.3 Install device

- ✓ Process pipework has been properly prepared.
- ✓ Process pipework has been secured against unintentional opening with shut-off valves.
- ✓ Installation position vertical, direction of flow from bottom to top.

#### **WARNING**

##### Risk of injury and poisoning due to medium spraying out.

- ▶ Ensure that in case of a break in the measuring tube, no hazards result from escaping media.
- ▶ Do not use measuring tube made of PVC for gaseous media.

#### **WARNING**

##### Risk of injury and poisoning due to medium spraying out.

- ▶ Use personal protective equipment when carrying out any work on the fitting.

1. Ensure that measuring tube (6) and float (4) are clean and free of foreign matter.
2. Remove transport lock (holds the float).
3. Ensure that the float (4) can move freely.

#### 5.3.2 Connection with union nut and insert

1. Unscrew both union nuts (1) (→ Figure Layout, Page 5 ).
  - Secure float (heavy) from falling
2. Push union nuts (1) onto spigot of process pipes. Check mounting direction.
3. Weld union end (2) of device to spigot of process pipes.
4. Check fit of O-rings.
5. Connect device to the process pipework. Tighten union nuts (1) by hand only.

#### 5.3.3 Connection with flange

1. Prepare pipe ends according to connection type.
2. Radially push the fitting and flat seal between the flange ends.
3. Bolt fitting and flange with flange screws, nuts and washers.
 

While doing so, observe tightening torques: (→ 9.2 Tightening torques, Page 12).

#### 5.3.4 If necessary: Attach special scale

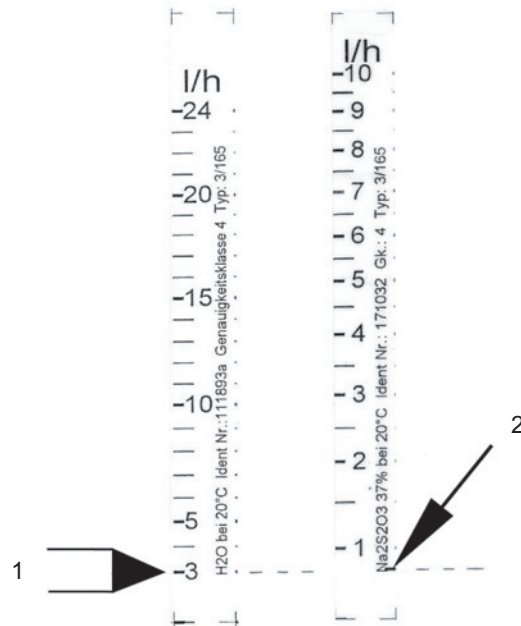

1. With a pen, mark the lowest reading point of the existing scale on the measuring tube (1).
2. Pull current scale off.
3. Stick new scale on so that the marking on the measuring tube matches with the lowest reading point (2).

### 5.4 Performing the hydrostatic test

**i** Perform hydrostatic test using neutral medium, e.g. water.

1. Pressurize the device, ensuring
  - Test pressure < 1.5 x P<sub>N</sub> (Nominal pressure)
  - Test pressure < P<sub>N</sub> + 5 bar
  - Test pressure < permissible system pressure
2. Check that the device is not leaking.



## 6 Operation

### 6.1 Commissioning

- ✓ Device is connected properly to the process pipework.
- 1. Open throttle valves in inlet and outlet line.
- 2. Ensure that the float can float freely and measures a plausible value.

### 6.2 Read measurement

-  For the measurement range 2,500-25,000, the reading edge is below the float fixture (largest diameter)

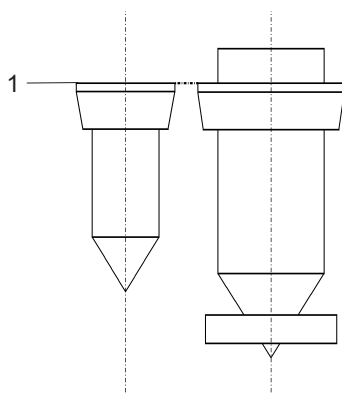

1 Reading edge

- ▶ Read measurement using face (1) of float.

# 7 Maintenance

**⚠ WARNING**

**Risk of injury and poisoning due to hazardous or hot media.**

- ▶ Use personal protective equipment when carrying out any work on the device.
- ▶ Allow device to cool.
- ▶ Make sure the device is depressurized.
- ▶ Block the media supply to the device.
- ▶ Empty the process pipework, safely collect the media and dispose of it in accordance with environmental regulations.
- ▶ Switch off the power supply to the system.
- ▶ Secure power supply against being switched back on again.
- ▶ Provide warning of maintenance and repair work and set up warning signs.

## 7.1 Servicing

Interval	Action
As necessary	▶ Clean device with a damp cloth.
Six-monthly	▶ Visual and function check: <ul style="list-style-type: none"> <li>– Normal operating conditions unchanged</li> <li>– No leaks</li> <li>– Measuring tube and float for deposits or changes to surface</li> </ul>

Tab. 3 Servicing activities

- ▶ Perform maintenance tasks according to the table.

## 7.2 Maintenance

**⚠ WARNING**

**Risk of injury during disassembly!**

- ▶ Wear protective gloves, components can be very sharp-edged due to wear or damage.

### 7.2.1 Removing fitting

1. Ensure that:
  - System is empty
  - System has been flushed
  - System is depressurized
  - System has cooled down
  - System is secured against being switched back on again
2. Remove fitting from the pipe.
3. Decontaminate fitting if required.
  - Dead space in the fitting may still contain medium.

## 7.3 Replacement parts and return

1. Have the following information ready to hand when ordering spare parts (→ 3.1.1 Name plate, Page 5 ).
  - Device type
  - ID number
  - Nominal pressure and diameter
  - Connection and gasket material
2. Please complete and enclose the document of compliance for returns (→ [www.asv-stuebbe.com/service/downloads](http://www.asv-stuebbe.com/service/downloads)).



3. Only use spare parts from ASV Stübbe.

## 8 Troubleshooting

**⚠ WARNING**

**Risk of injury and poisoning due to hazardous media liquids!**

- ▶ Use personal protective equipment when carrying out any work on the device.
- ▶ Additional troubleshooting

Error	Possible cause	Corrective action
Medium is leaking out of the flange	Pre-tension of the O-ring too small	▶ Retighten union nut by hand.
Measurements difficult to read	Scale dirty or damaged	▶ Clean scale. ▶ Replace scale.
	Measuring tube dirty	▶ Clean or replace measuring tube (→ 8.1 Clean measuring tube and float, Page 11).
Defective display	Float jammed	▶ Clean measuring tube and float (→ 8.1 Clean measuring tube and float, Page 11).
	Float weight defective	▶ Check weight of float: <ul style="list-style-type: none"> <li>• Ask for weight from manufacturer</li> <li>• If weight differs, remove device, insert new float and re-install device (→ 8.1 Clean measuring tube and float, Page 11).</li> </ul>
No display (only for measurement sensor ZE3000, ZE3075 or limit sensor)	Float installed incorrectly	▶ Ensure that a float with magnet is used.

Tab. 4 Troubleshooting

### 8.1 Clean measuring tube and float

- ✓ System is empty.
  - ✓ System has been flushed.
  - ✓ System is depressurized.
  - ✓ System has cooled down.
  - ✓ System is secured against being switched back on again.
1. Unscrew both union nuts.
    - Secure float (heavy) from falling.
  2. Remove device from pipe.
  3. Ensure that measuring tube and float are clean and free of foreign matter.
    - If necessary, replace with new device.
  4. Ensure that the float can move freely.
  5. Install device (→ 5.3 Install device, Page 8).

## 9 Appendix

### 9.1 Technical specifications

#### 9.1.1 Mechanical specifications

Size	Value
<b>Process conditions (medium)</b>	
Pressure and temperature	See material-dependent pressure/temperature diagram (→ Data sheet).
<b>Materials in contact with medium</b>	
Measuring tube	PVC, PSU, PA, PVDF
Float	PVDF
Float catcher	PVDF
Insert	PVC, PP, PVDF
O-ring	FPM, EPDM
<b>Materials not in contact with medium</b>	
Setpoint indicator	PE
Union nut	PVC, PP, PVDF

Tab. 5 Mechanical specifications

#### 9.1.2 Dimensions

 Dimensions (→ Data sheet).

### 9.2 Tightening torques

Description	Tightening torque [Nm] for the sizes d [mm]							
	16	20	25	32	40	50	63	75
Flange GFK	5	7	10	15	20	25	32	37
Flange PP/steel	-	10	15	15	20	25	35	40

Tab. 6 Tightening torques

1) Greased housing screws (hex screws, hex nuts)

### 9.3 Accessories

Description
Flow data sensor
<ul style="list-style-type: none"> <li>• ZE 3000 – magnet angle sensor</li> <li>• ZE 3075 – Reed chain</li> </ul>
Float with liquid-tight encapsulated magnet (available complete with measuring tube)
Limit reed switch

Tab. 7 Accessories