

## Water-jet pump SP 820



### Advantage

- simple maintenance
- no moving parts
- very low wear
- low investment costs
- can also be used for aggressive media
- very good mixing effect
- high operating reliability
- low space requirement

### Application

- chemical plants
- water treatment
- electroplating plants

### Intended Use

- for mixing, dosing and delivering fluids
- for evacuating air in pipes and containers
- for pumping out containers or pits

### Function

- Propulsion fluid flows in the main flow direction through a nozzle fitted in the water-jet pump. The cross-section constriction caused by the nozzle bore causes acceleration of the propulsion fluid and thus a vacuum in the area of the suction socket that primes any provided fluid or gaseous media.
- The intake quantity is a function of the propulsion fluid pressure and the nozzle bore. For the standard values for the intake quantity please refer to the diagram.

### Intake Quantity

- For standard values see diagrams.

### Design

- We recommend an empirical determination by adapting the nozzle bore to the desired operating point. For standard values see diagrams.

### Attention

- The nozzles are provided as standard without bore!

### Flow Media

- Technically pure, neutral or aggressive fluid or gaseous media, provided that the valve components coming into contact with the media are resistant at the operating temperature according to the ASV-resistance guide!

### Nominal Pressure (H<sub>2</sub>O, 20°C)

- PN 10

### Fluid Temperature

- see pressure-/temperature diagram

### Operating Pressure

- see pressure-/temperature diagram

### Size

- DN 10 - DN 80

### Body

- PVC-U
- PP
- PVDF

### Sealing

- FPM
- EPDM

### Connection

- DN 10 to DN 50: housing with union DIN 8063
- DN 65 to DN 80: housing with spigot

### Flow Direction

- always in the direction of the arrow

### Colour

- body: PVC-U, grey, RAL 7011
- body: PP, grey, RAL 7032
- body: PVDF, opaque, yellowish-white

## Water-jet pump SP 820

### Pressure/temperature diagram

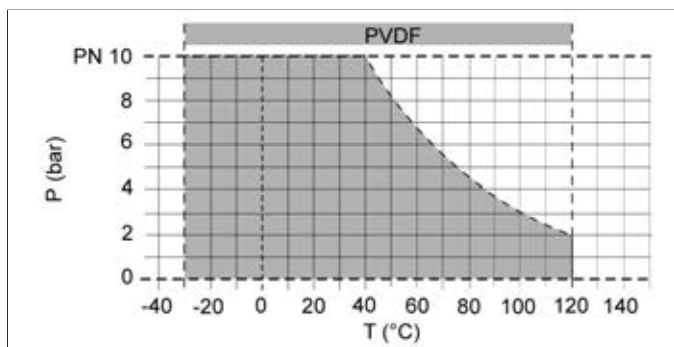
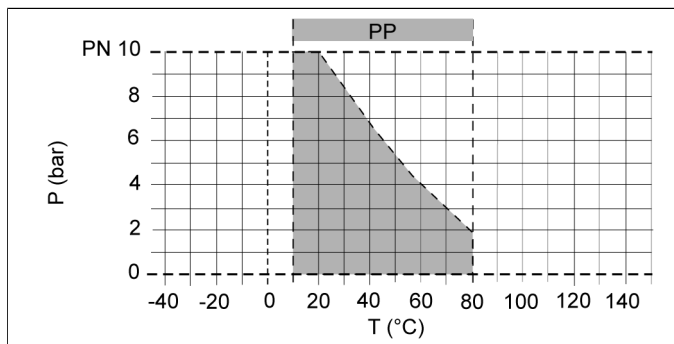
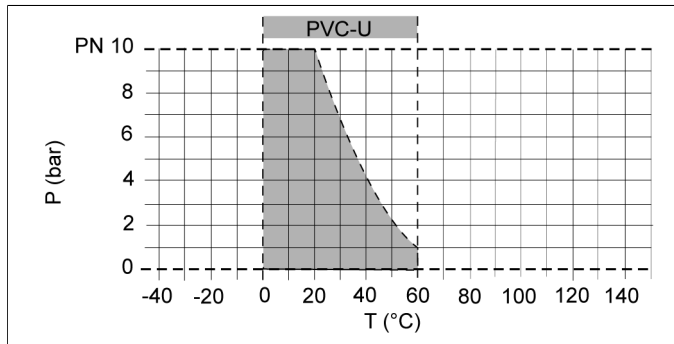

$P$  = operating pressure

$T$  = temperature

The pressure/temperature limits are applicable for the stated nominal pressures and a computed operating life factor of 25 years. These are standard values for harmless media (DIN 2403), to which the valve material is resistant.

For other media please refer to the ASV resistance guide.

The durability of wear parts depends on the operating conditions of the application.

For temperatures below 0°C (PP < +10°C) please specify the precise operating conditions of the application.

The rated pressure depends on the valve size and material. For the corresponding rated pressure value of the valve, please refer to the »Order table«.

### Design

#### Example 1:

The propulsion water pressure and/or propulsion water quantity for:

- intake quantity of 900 l/h H<sub>2</sub>O
- counterpressure of 1 bar

According to the diagram:

- propulsion water pressure approx. 2.5 bar
- propulsion water quantity approx. 1.100 l/h

#### Example 2:

The intake quantity for:

- propulsion water pressure of 5 bar is required
- counterpressure of 1.5 bar

According to the diagram:

- intake quantity approx. 1.080 l/h

### Water-Jet Pump SP 820 DN 25, nozzle bore 4.0 mm

Intake medium water

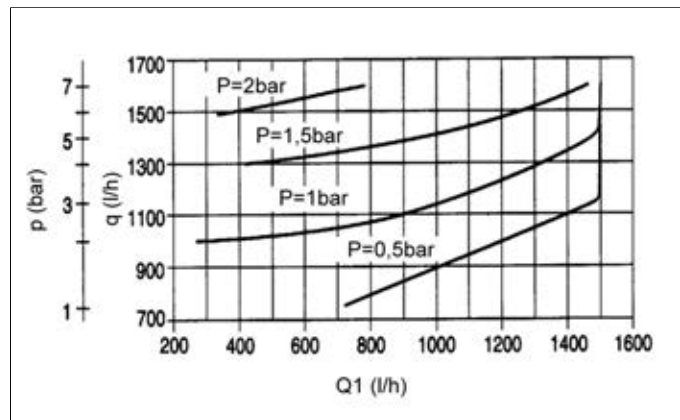

$p$  = propulsion water pressure (bar)

$q$  = propulsion water quantity (l/h)

$P$  = counterpressure (bar)

$Q_1$  = intake quantity (l/h) (water)

### Operating note

Safe operation of the valve can only be ensured if it is properly installed, operated, serviced or repaired by qualified personnel according to its intended use while observing the accident prevention regulations, safety regulations, relevant standards, directives/technical regulations or codes of practice such as e.g. DIN, DIN EN, DIN ISO and DVS\*. \*DVS = German Welding Society. The intended use includes adhering to specified limit values for pressure and temperature, as well as checking the resistance. This requires all components coming into contact with the medium to be "resistant" in accordance with the ASV resistance guide. Ensure that the flow direction coincides with the direction of the arrow.

Provide a damping zone of at least 5 x DN upstream and downstream of the water-jet pump.

In order to meet the requirements of accuracy for mixing or dosing we recommend fitting suitable ASV throttle valves, ASV flowmeters and ASV diaphragm pressure gauge guards with pressure gauge.

## Water-jet pump SP 820, [d16 - d63]



### body PVC-U

<i>size</i>	d(mm)	16	20	25	32	40	50	63	
	<i>pressure range</i>	DN(mm)	10	15	20	25	32	40	50
		DN(inch)	3/8	1/2	3/4	1	1 1/4	1 1/2	2
		PN(bar)	10	10	10	10	10	10	10
<i>Connection</i>	<i>sealing</i>	<i>ident No.</i>							
	PVC-U socket end DIN ISO	EPDM <i>weight</i>	54385 0.15 kg	54386 0.20 kg	54389 0.35 kg	54387 0.45 kg	54388 0.80 kg	54390 1.30 kg	54391 2.35 kg

### body PP

<i>size</i>	d(mm)	16	20	25	32	40	50	63	
	<i>pressure range</i>	DN(mm)	10	15	20	25	32	40	50
		DN(inch)	3/8	1/2	3/4	1	1 1/4	1 1/2	2
		PN(bar)	10	10	10	10	10	10	10
<i>Connection</i>	<i>sealing</i>	<i>ident No.</i>							
	PP socket end DIN ISO	EPDM <i>weight</i>	61385 0.11 kg	59679 0.15 kg	57140 0.25 kg	60123 0.32 kg	59794 0.56 kg	59698 0.91 kg	61335 3.06 kg

### body PVDF

<i>size</i>	d(mm)	16	20	25	32	40	50	63	
	<i>pressure range</i>	DN(mm)	10	15	20	25	32	40	50
		DN(inch)	3/8	1/2	3/4	1	1 1/4	1 1/2	2
		PN(bar)	10	10	10	10	10	10	10
<i>Connection</i>	<i>sealing</i>	<i>ident No.</i>							
	PVDF socket end DIN ISO	FPM <i>weight</i>	60997 0.20 kg	59800 0.26 kg	67425 0.50 kg	59464 0.59 kg	54380 1.05 kg	65591 1.70 kg	67883 3.06 kg

## Water-jet pump SP 820, [d16 - d63]

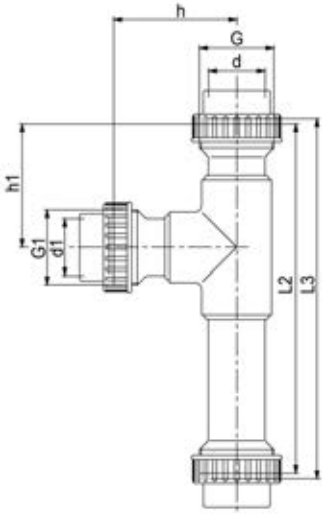

### dimensions

d(mm)	16	20	25	32	40	50	63
DN(mm)	10	15	20	25	32	40	50
DN(inch)	3/8	1/2	3/4	1	1 1/4	1 1/2	2

### dimensions(mm)

d1	16	16	16	32	40	50	63
G	3/4	1	1 1/4	1 1/2	2	2 1/4	2 3/4
G1	3/4	3/4	3/4	1 1/2	2	2 1/4	2 3/4
h	35	35	45	71	87	105	128
h1	40	40	45	71	87	105	128
L2	110	110	145	195	239	301	351
L3	116	116	151	201	245	307	357

## Water-jet pump SP 820, [d75 - d90]



### body PVC-U

<i>size</i> <i>pressure range</i>	d(mm)		75	90
	DN(mm)		65	80
	DN(inch)		2 1/2	3
	PN(bar)		10	10
<i>Connection</i>	<i>sealing</i>	<i>ident No.</i>		
PVC-U spigot end DIN ISO	EPDM <i>weight</i>		64866 2.40 kg	61352 4.10 kg

### body PP

<i>size</i> <i>pressure range</i>	d(mm)		75	90
	DN(mm)		65	80
	DN(inch)		2 1/2	3
	PN(bar)		10	10
<i>Connection</i>	<i>sealing</i>	<i>ident No.</i>		
PP spigot end DIN ISO	EPDM <i>weight</i>		65948 1.70 kg	65949 2.90 kg

### body PVDF

<i>size</i> <i>pressure range</i>	d(mm)		75	90
	DN(mm)		65	80
	DN(inch)		2 1/2	3
	PN(bar)		10	10
<i>Connection</i>	<i>sealing</i>	<i>ident No.</i>		
PVDF spigot end DIN ISO	FPM <i>weight</i>		67884 3.15 kg	65592 5.35 kg

## Water-jet pump SP 820, [d75 - d90]

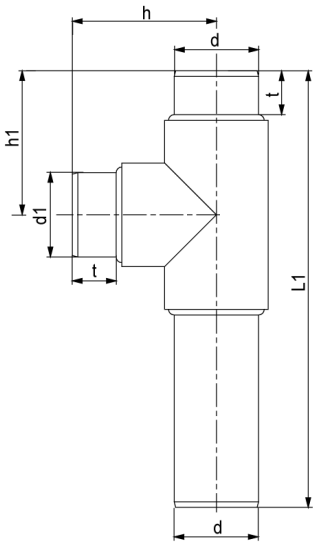

### dimensions

d(mm)	75	90
DN(mm)	65	80
DN(inch)	2 1/2	3
dimensions(mm)		
d1	75	90
h	115	149
h1	115	149
L1	388	465

# Water-jet pump SP 820

## Characteristic curves

### SP 820, DN 10, nozzle bore 1,5 mm

Intake medium water

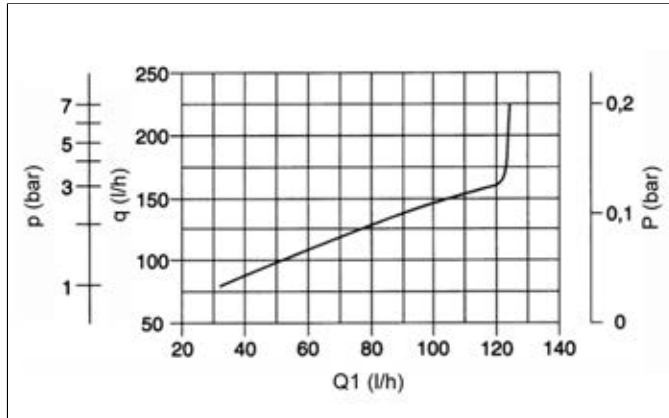

### SP 820, DN 10, nozzle bore 1,5 mm

Intake medium air

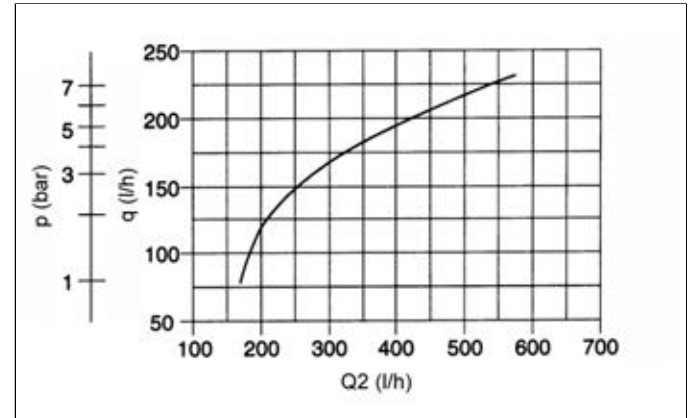

### SP 820, DN 10, nozzle bore 2,0 mm

Intake medium water

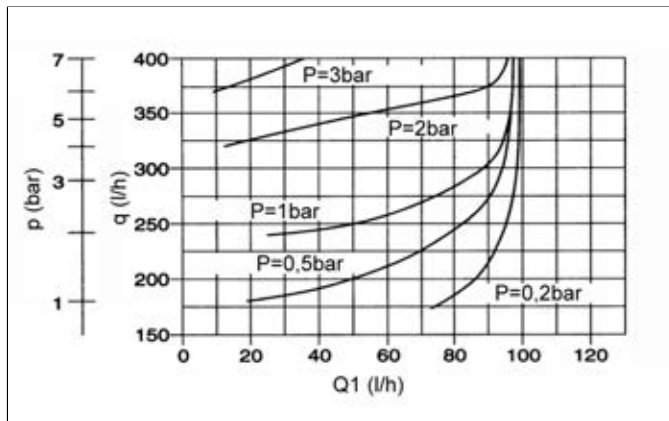

### SP 820, DN 10, nozzle bore 2,0 mm

Intake medium air

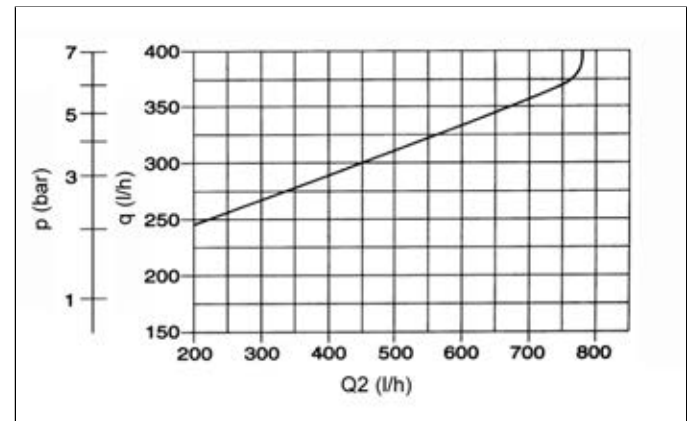

### SP 820, DN 15, nozzle bore 2,0 mm

Intake medium water

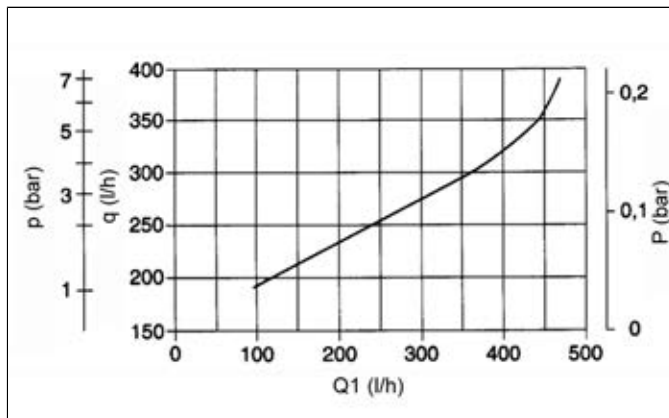

### SP 820, DN 15, nozzle bore 2,0 mm

Intake medium air

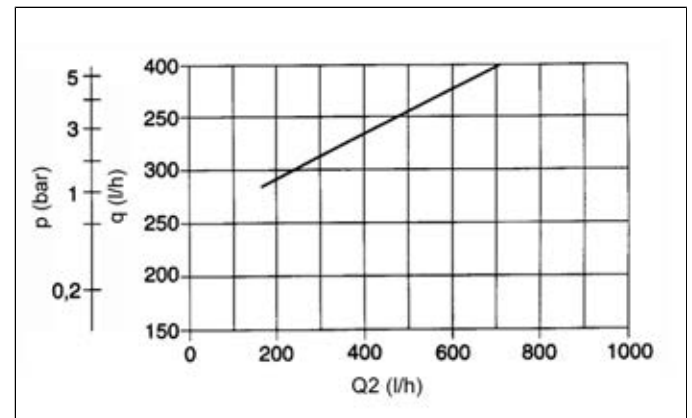

$p$  = propulsion water pressure (bar)  
 $q$  = propulsion water quantity (l/h)  
 $P$  = counterpressure (bar)  
 $Q_1$  = intake quantity (l/h) (water)

$p$  = propulsion water pressure (bar)  
 $q$  = propulsion water quantity (l/h)  
 $P$  = counterpressure (bar)  
 $Q_2$  = intake quantity (l/h) (air)

## Water-jet pump SP 820

### SP 820, DN 15, nozzle bore 3,0 mm

Intake medium water

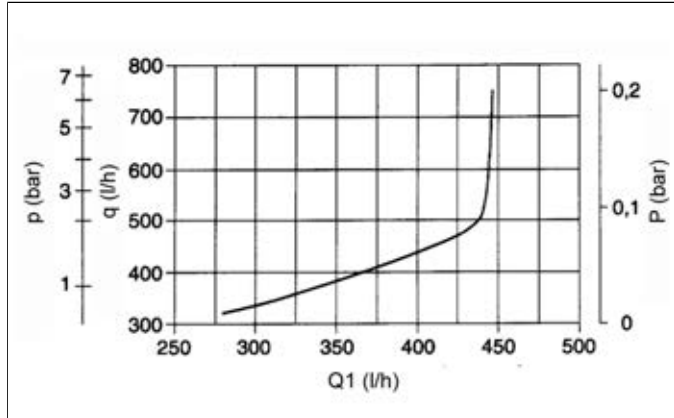

### SP 820, DN 15, nozzle bore 3,0 mm

Intake medium air

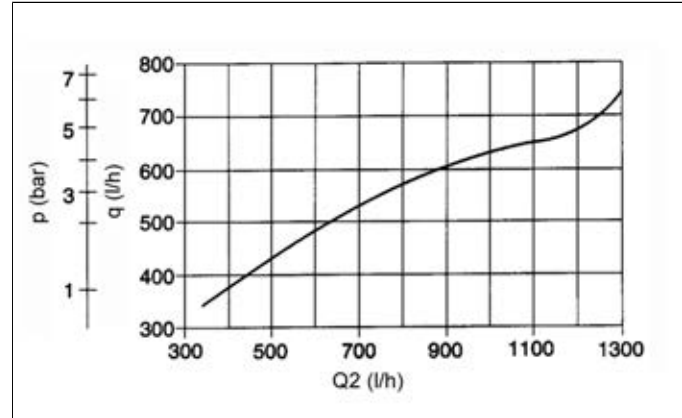

### SP 820, DN 15, nozzle bore 4,0 mm

Intake medium water

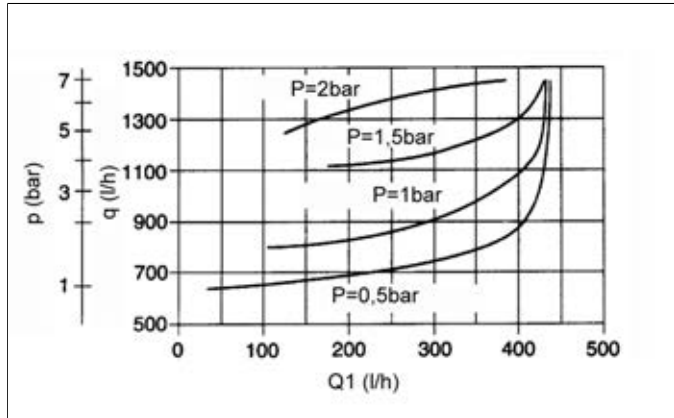

### SP 820, DN 15, nozzle bore 4,0 mm

Intake medium air

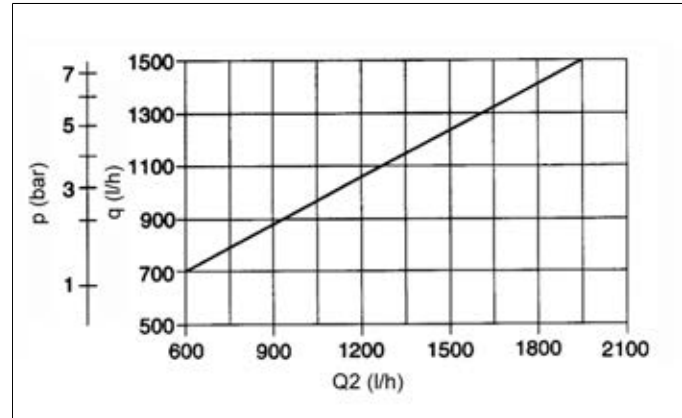

### SP 820, DN 20, nozzle bore 3,0 mm

Intake medium water

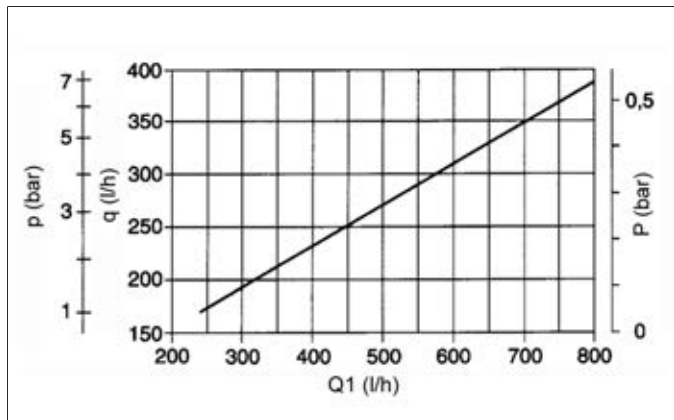

### SP 820, DN 20, nozzle bore 3,0 mm

Intake medium air

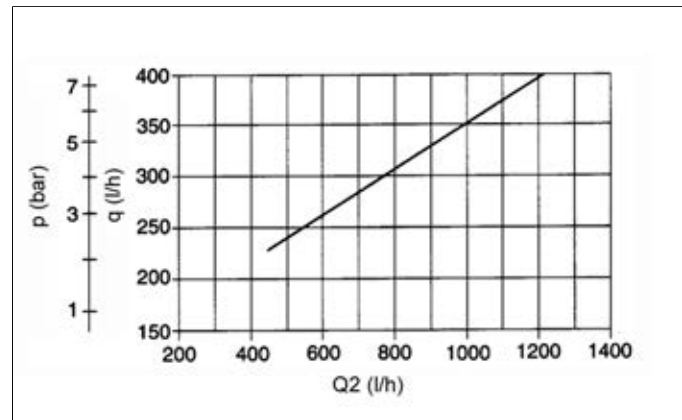

$p$  = propulsion water pressure (bar)  
 $q$  = propulsion water quantity (l/h)  
 $P$  = counterpressure (bar)  
 $Q_1$  = intake quantity (l/h) (water)

$p$  = propulsion water pressure (bar)  
 $q$  = propulsion water quantity (l/h)  
 $P$  = counterpressure (bar)  
 $Q_2$  = intake quantity (l/h) (air)



# Water-jet pump SP 820

## SP 820, DN 20, nozzle bore 4,5 mm

Intake medium water

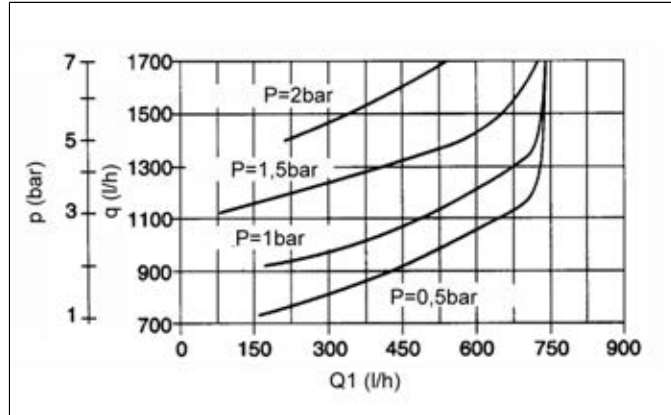

## SP 820, DN 20, nozzle bore 4,5 mm

Intake medium air

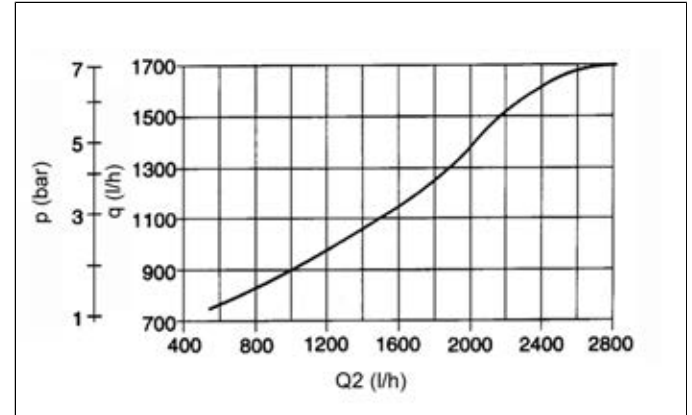

## SP 820, DN 20, nozzle bore 6,0 mm

Intake medium water

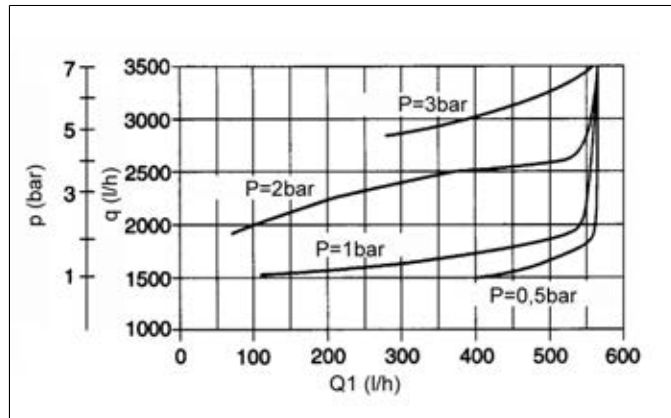

## SP 820, DN 20, nozzle bore 6,0 mm

Intake medium air

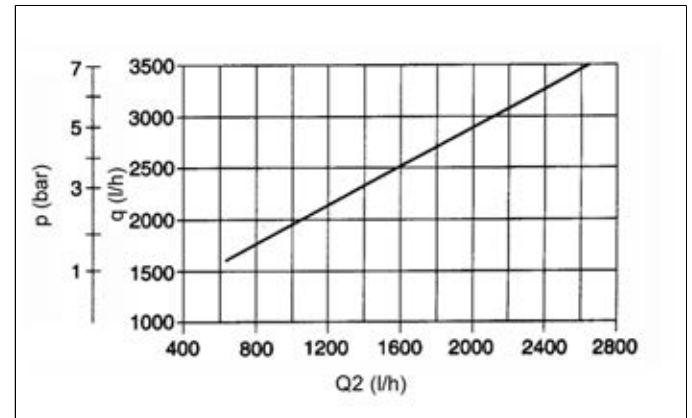

## SP 820, DN 25, nozzle bore 2,5 mm

Intake medium water

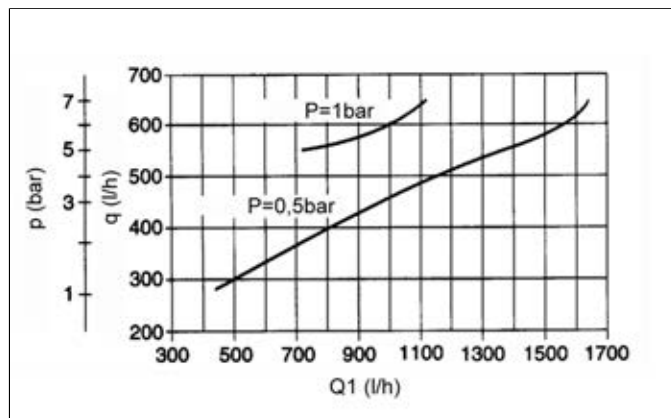

## SP 820, DN 25, nozzle bore 2,5 mm

Intake medium air

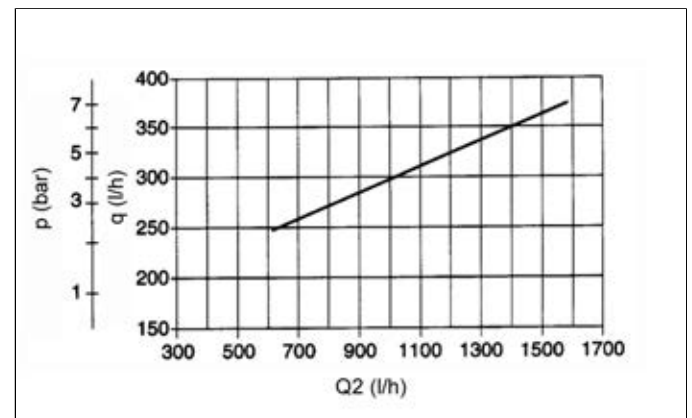

$p$  = propulsion water pressure (bar)  
 $q$  = propulsion water quantity (l/h)  
 $P$  = counterpressure (bar)  
 $Q_1$  = intake quantity (l/h) (water)

$p$  = propulsion water pressure (bar)  
 $q$  = propulsion water quantity (l/h)  
 $P$  = counterpressure (bar)  
 $Q_2$  = intake quantity (l/h) (air)

## Water-jet pump SP 820

### SP 820, DN 25, nozzle bore 4,0 mm

Intake medium water

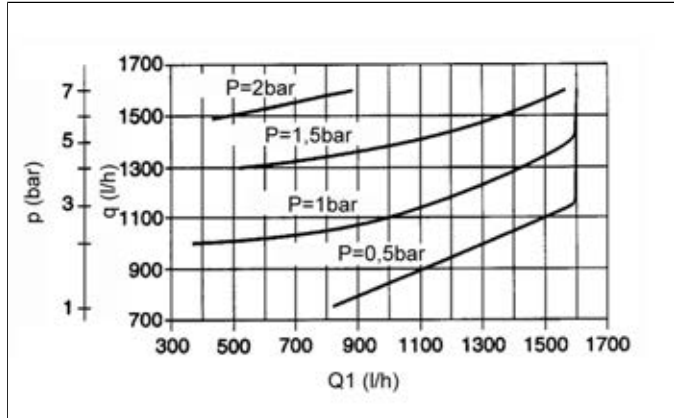

### SP 820, DN 25, nozzle bore 4,0 mm

Intake medium air

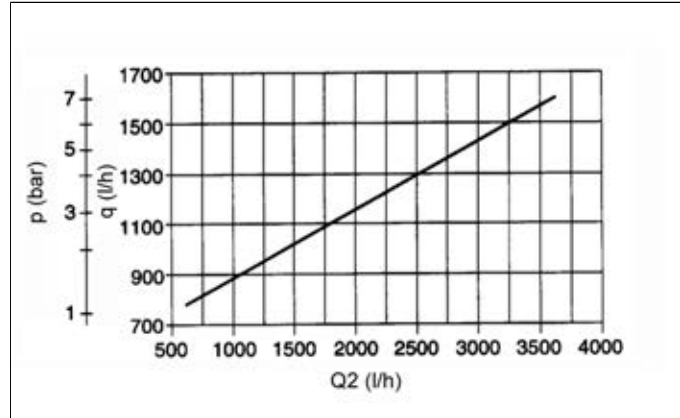

### SP 820, DN 25, nozzle bore 5,0 mm

Intake medium water

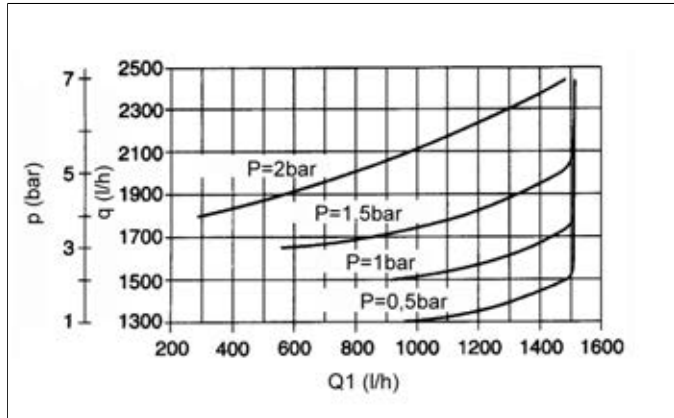

### SP 820, DN 25, nozzle bore 5,0 mm

Intake medium air

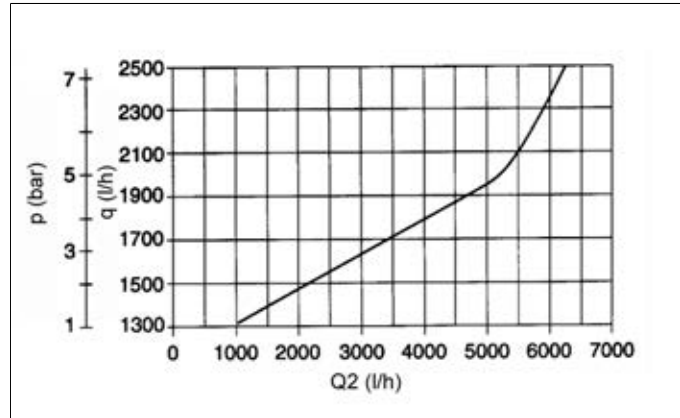

### SP 820, DN 32, nozzle bore 3,0 mm

Intake medium water

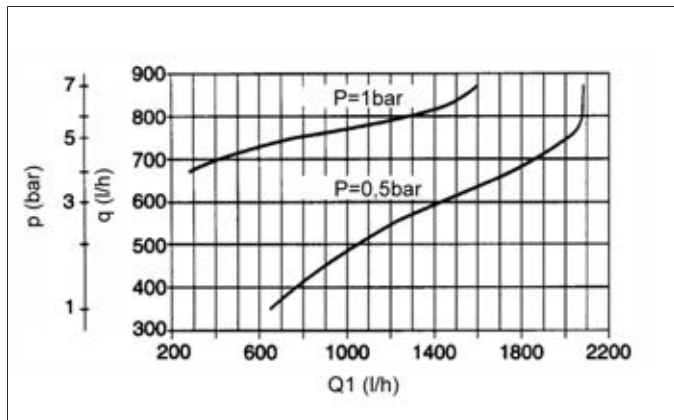

### SP 820, DN 32, nozzle bore 3,0 mm

Intake medium air

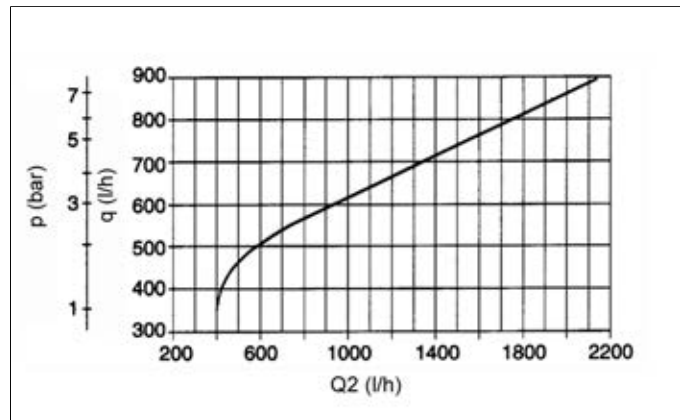

$p$  = propulsion water pressure (bar)  
 $q$  = propulsion water quantity (l/h)  
 $P$  = counterpressure (bar)  
 $Q_1$  = intake quantity (l/h) (water)

$p$  = propulsion water pressure (bar)  
 $q$  = propulsion water quantity (l/h)  
 $P$  = counterpressure (bar)  
 $Q_2$  = intake quantity (l/h) (air)

## Water-jet pump SP 820

### SP 820, DN 32, nozzle bore 4,5 mm

Intake medium water

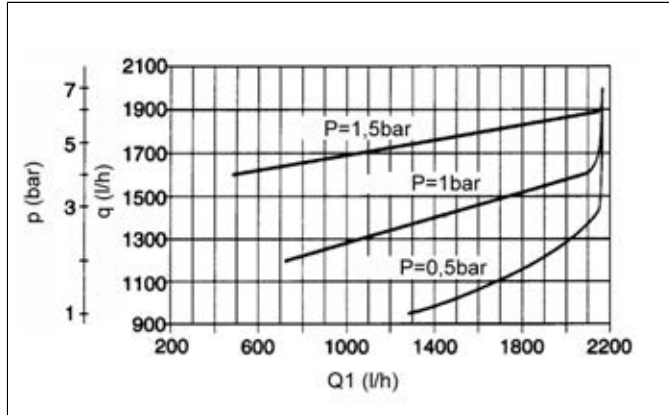

### SP 820, DN 32, nozzle bore 4,5 mm

Intake medium air

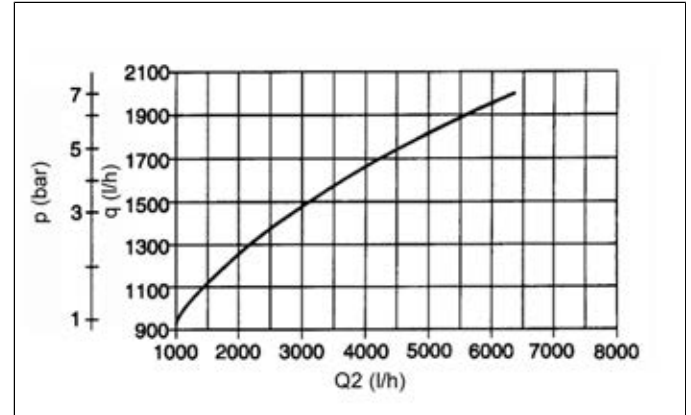

### SP 820, DN 32, nozzle bore 6,0 mm

Intake medium water

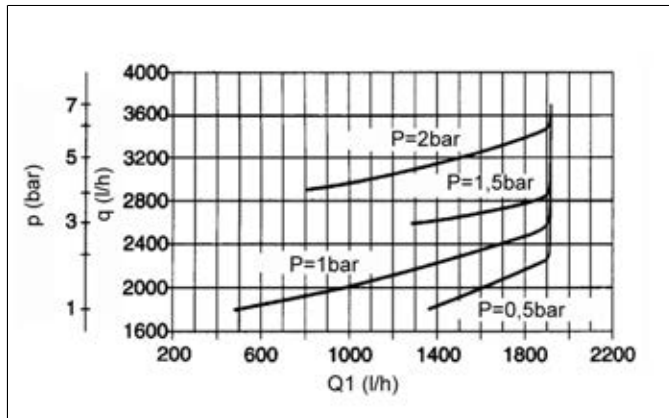

### SP 820, DN 32, nozzle bore 6,0 mm

Intake medium air

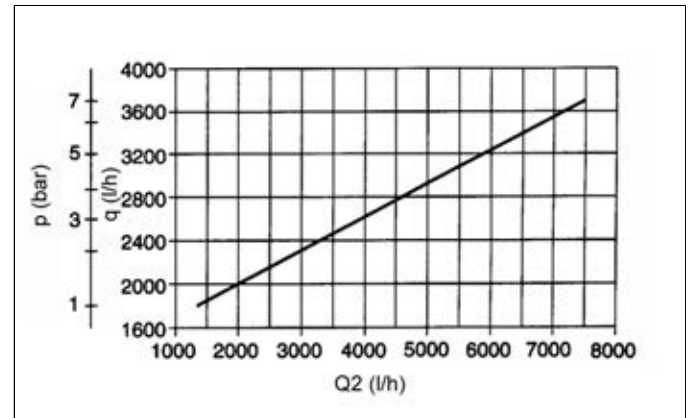

### SP 820, DN 40, nozzle bore 3,5 mm

Intake medium water

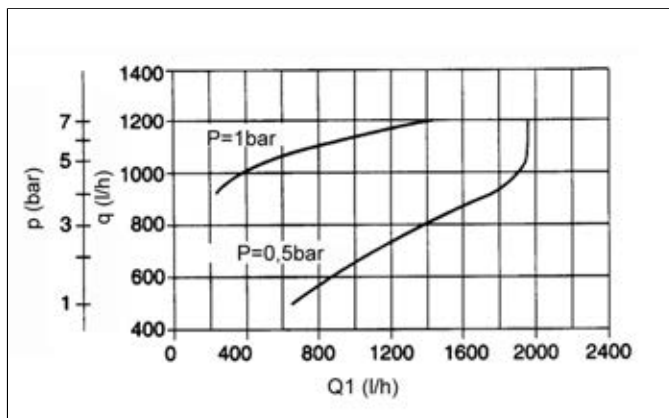

### SP 820, DN 40, nozzle bore 3,5 mm

Intake medium air

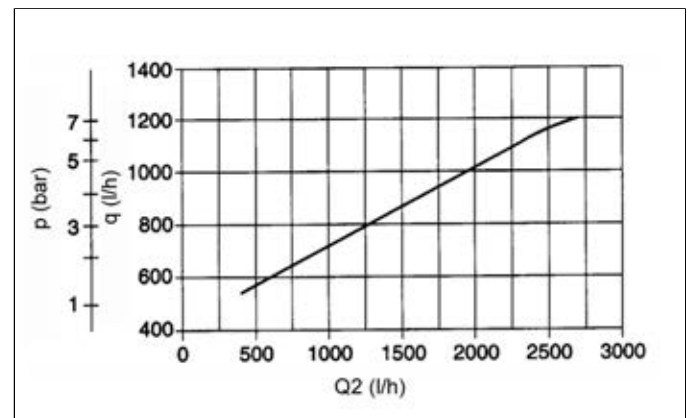

$p$  = propulsion water pressure (bar)  
 $q$  = propulsion water quantity (l/h)  
 $P$  = counterpressure (bar)  
 $Q_1$  = intake quantity (l/h) (water)

$p$  = propulsion water pressure (bar)  
 $q$  = propulsion water quantity (l/h)  
 $P$  = counterpressure (bar)  
 $Q_2$  = intake quantity (l/h) (air)

## Water-jet pump SP 820

### SP 820, DN 40, nozzle bore 5,5 mm

Intake medium water

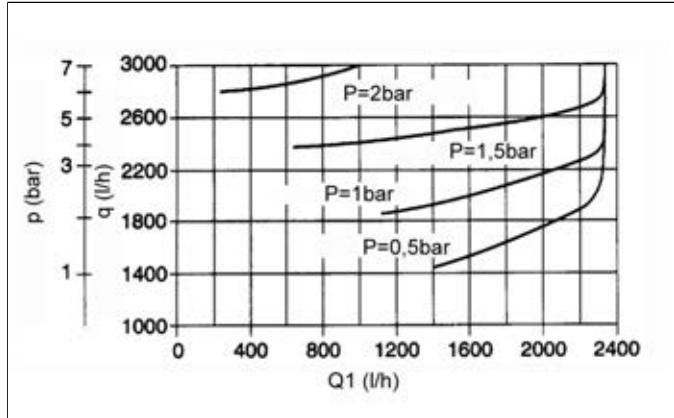

### SP 820, DN 40, nozzle bore 5,5 mm

Intake medium air

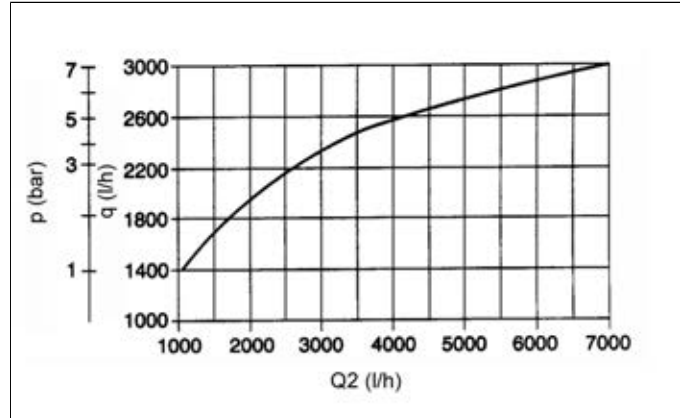

### SP 820, DN 40, nozzle bore 7,5 mm

Intake medium water

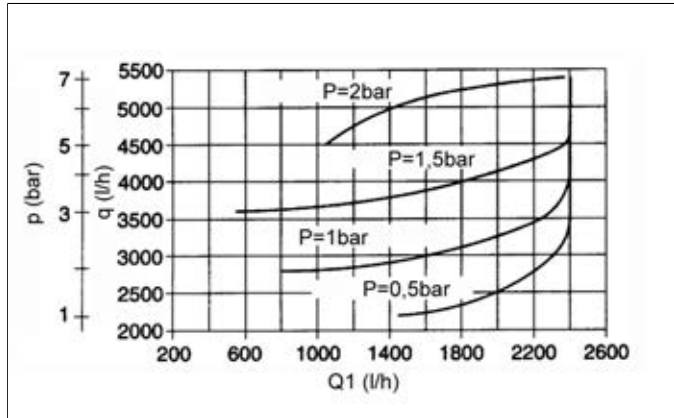

### SP 820, DN 40, nozzle bore 7,5 mm

Intake medium air

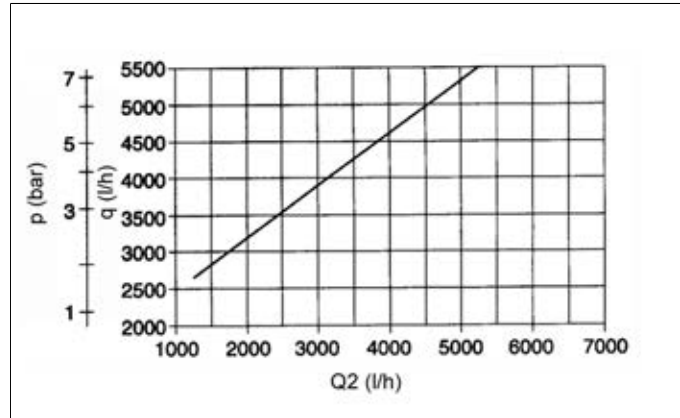

### SP 820, DN 50, nozzle bore 5,0 mm

Intake medium water

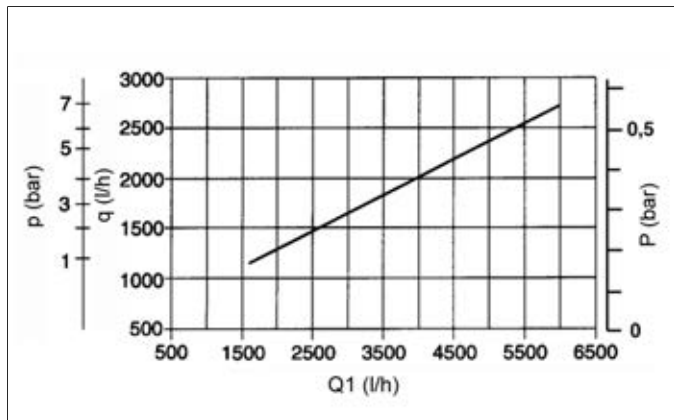

### SP 820, DN 50, nozzle bore 5,0 mm

Intake medium air

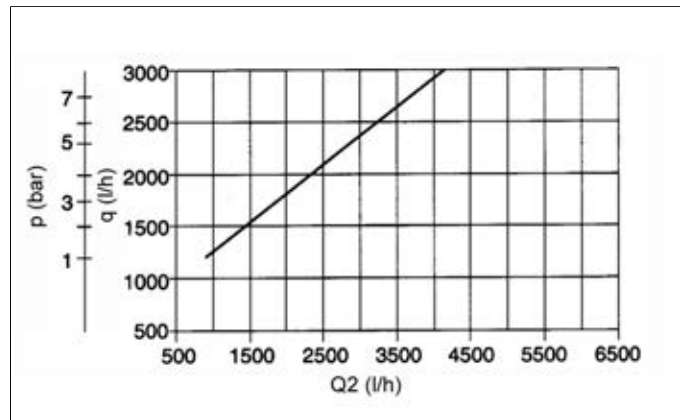

$p$  = propulsion water pressure (bar)  
 $q$  = propulsion water quantity (l/h)  
 $P$  = counterpressure (bar)  
 $Q_1$  = intake quantity (l/h) (water)

$p$  = propulsion water pressure (bar)  
 $q$  = propulsion water quantity (l/h)  
 $P$  = counterpressure (bar)  
 $Q_2$  = intake quantity (l/h) (air)

# Water-jet pump SP 820

## SP 820, DN 50, nozzle bore 7,0 mm

Intake medium water

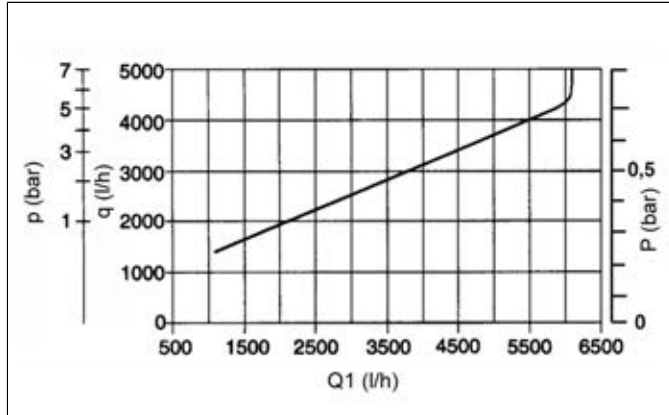

## SP 820, DN 50, nozzle bore 7,0 mm

Intake medium air

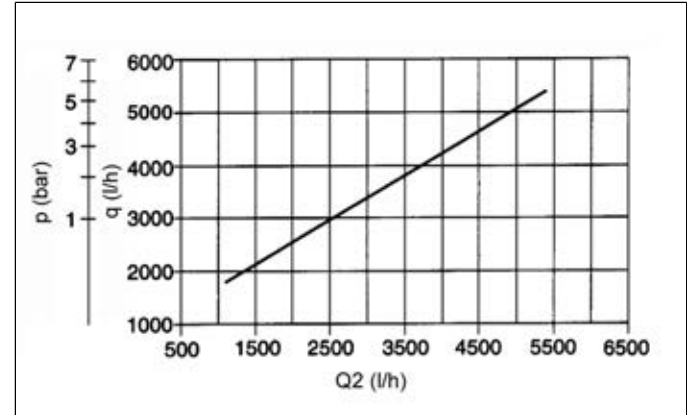

## SP 820, DN 50, nozzle bore 9,0 mm

Intake medium water

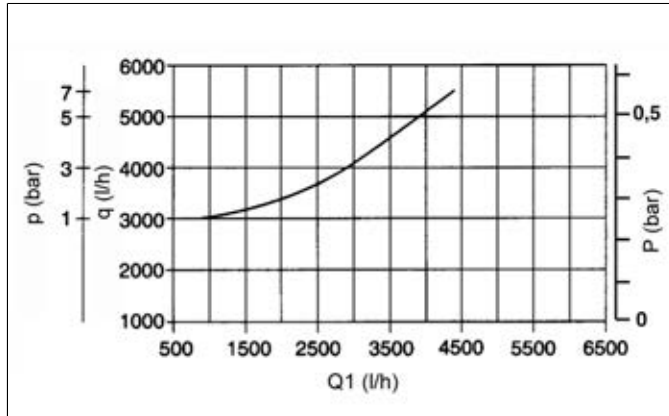

## SP 820, DN 50, nozzle bore 9,0 mm

Intake medium air

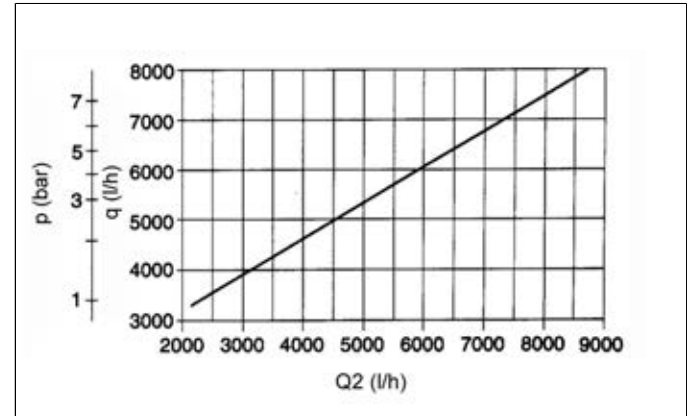

## SP 820, DN 65, nozzle bore 6,5 mm

Intake medium water

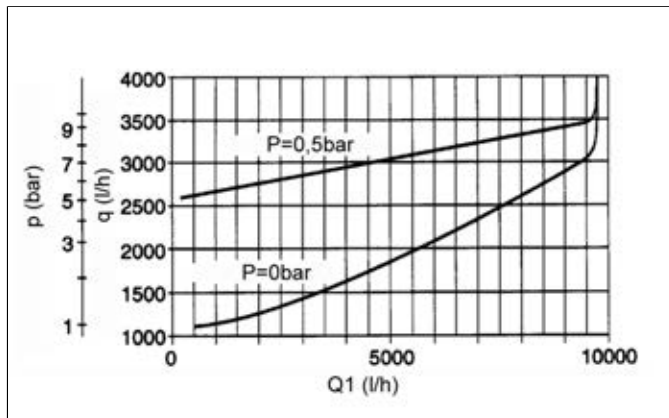

## SP 820, DN 65, nozzle bore 6,5 mm

Intake medium air

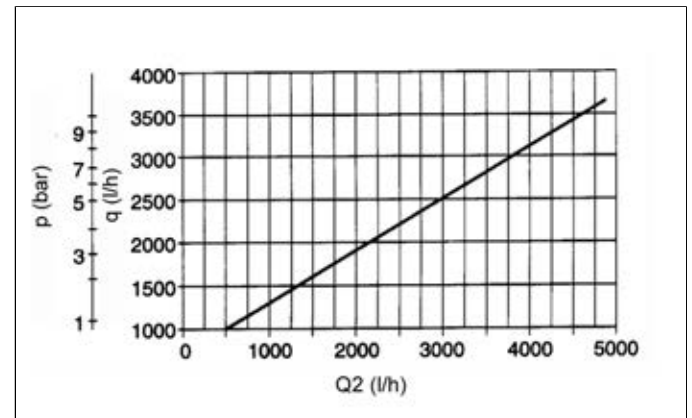

$p$  = propulsion water pressure (bar)  
 $q$  = propulsion water quantity (l/h)  
 $P$  = counterpressure (bar)  
 $Q_1$  = intake quantity (l/h) (water)

$p$  = propulsion water pressure (bar)  
 $q$  = propulsion water quantity (l/h)  
 $P$  = counterpressure (bar)  
 $Q_2$  = intake quantity (l/h) (air)

## Water-jet pump SP 820

### SP 820, DN 65, nozzle bore 9,0 mm

Intake medium water

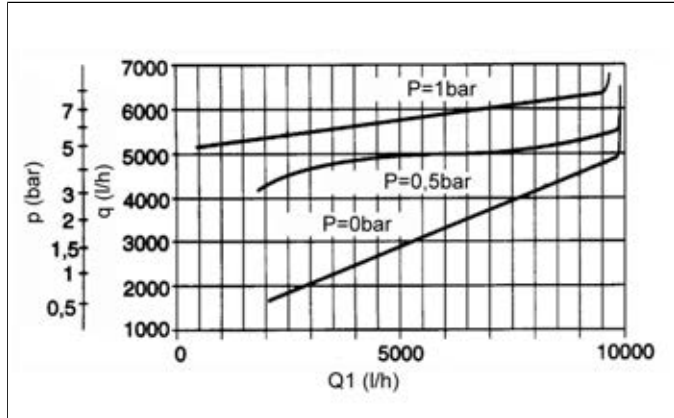

### SP 820, DN 65 nozzle bore 9,0 mm

Intake medium air

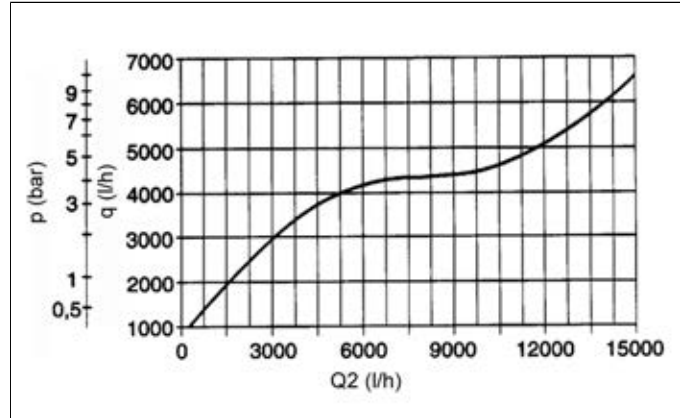

### SP 820, DN 65, nozzle bore 11,5 mm

Intake medium water

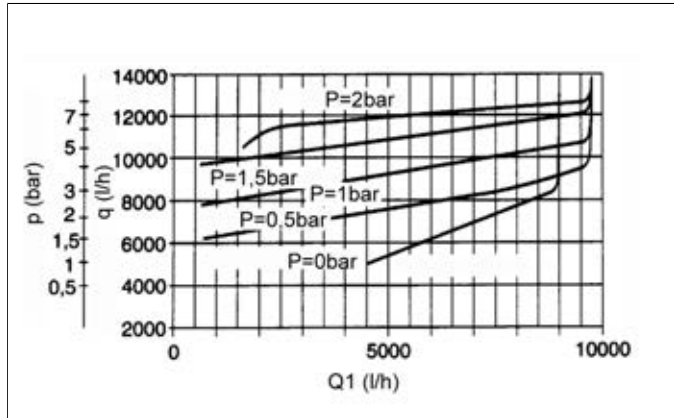

### SP 820, DN 65, nozzle bore 11,5 mm

Intake medium air

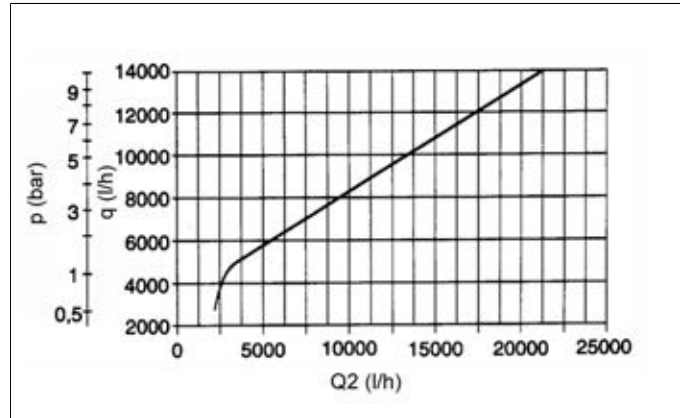

### SP 820, DN 80, nozzle bore 8,0 mm

Intake medium water

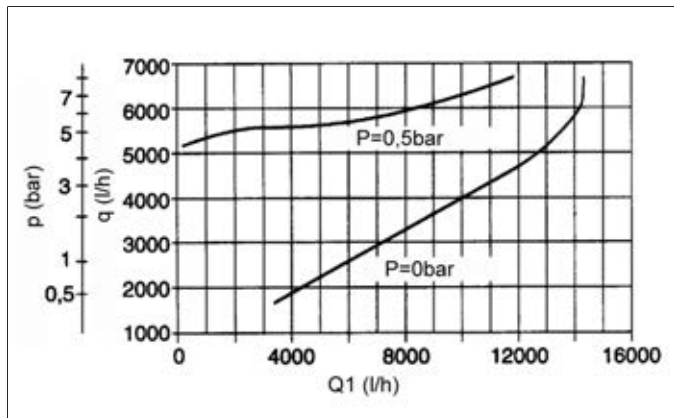

### SP 820, DN 80, nozzle bore 8,0 mm

Intake medium air

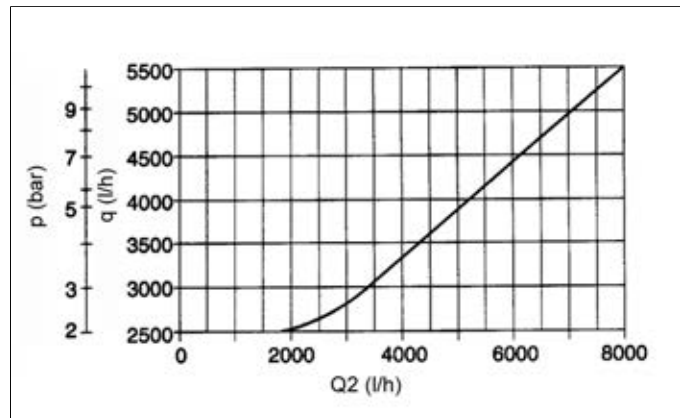

$p$  = propulsion water pressure (bar)  
 $q$  = propulsion water quantity (l/h)  
 $P$  = counterpressure (bar)  
 $Q_1$  = intake quantity (l/h) (water)

$p$  = propulsion water pressure (bar)  
 $q$  = propulsion water quantity (l/h)  
 $P$  = counterpressure (bar)  
 $Q_2$  = intake quantity (l/h) (air)

# Water-jet pump SP 820

## SP 820, DN 80 nozzle bore 11,0 mm

Intake medium water

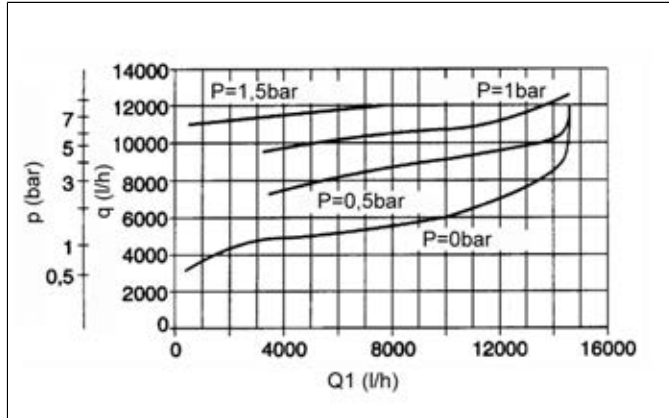

## SP 820, DN 80, nozzle bore 11,0 mm

Intake medium air

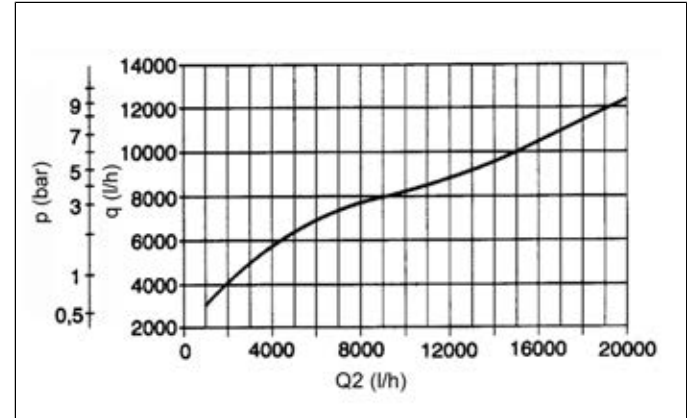

## SP 820, DN 80, nozzle bore 14,0 mm

Intake medium water

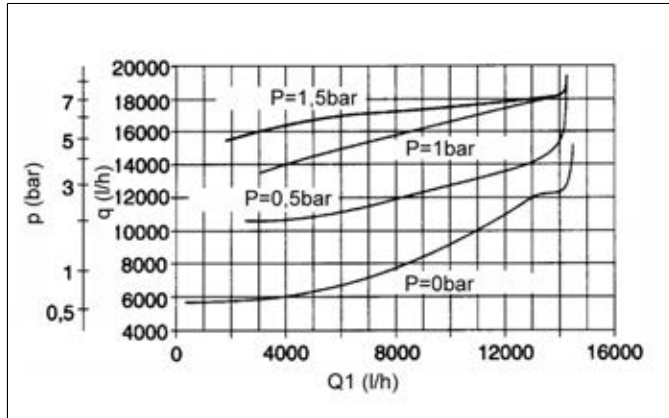

## SP 820, DN 80, nozzle bore 14,0 mm

Intake medium air

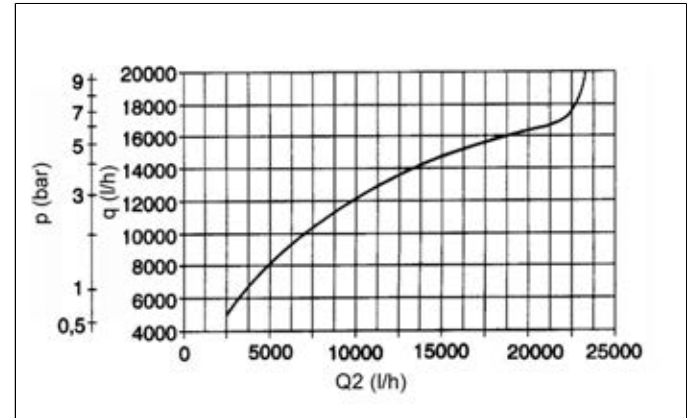

$p$  = propulsion water pressure (bar)  
 $q$  = propulsion water quantity (l/h)  
 $P$  = counterpressure (bar)  
 $Q_1$  = intake quantity (l/h) (water)

$p$  = propulsion water pressure (bar)  
 $q$  = propulsion water quantity (l/h)  
 $P$  = counterpressure (bar)  
 $Q_2$  = intake quantity (l/h) (air)

## Maximum vacuum achieved for water-jet pumps SP 820, DN 10

nozzle bore: 1,5; 2,0

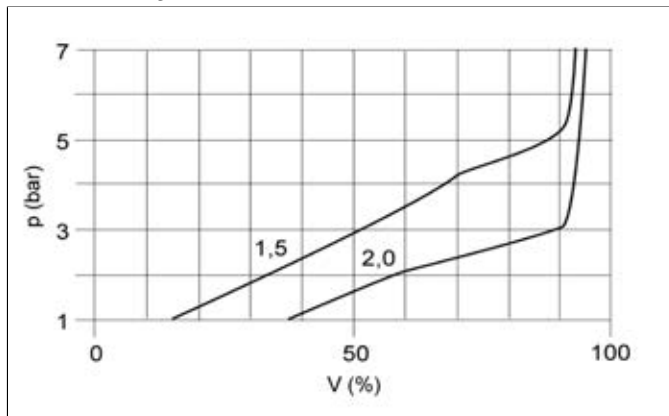

$p$  = propulsion water pressure (bar)  
 $V$  = vacuum (%)

## Maximum vacuum achieved for water-jet pumps SP 820, DN 15

nozzle bore: 2,0; 3,0; 4,0

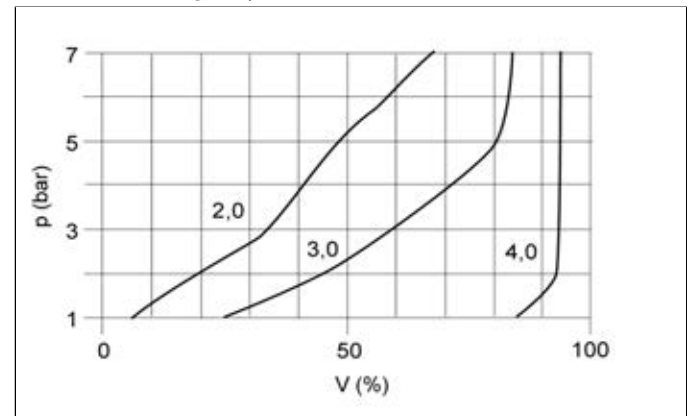

$p$  = propulsion water pressure (bar)  
 $V$  = vacuum (%)

## Water-jet pump SP 820

### Maximum vacuum achieved for water-jet pumps SP 820, DN 20

nozzle bore: 3,0; 4,5; 6,0

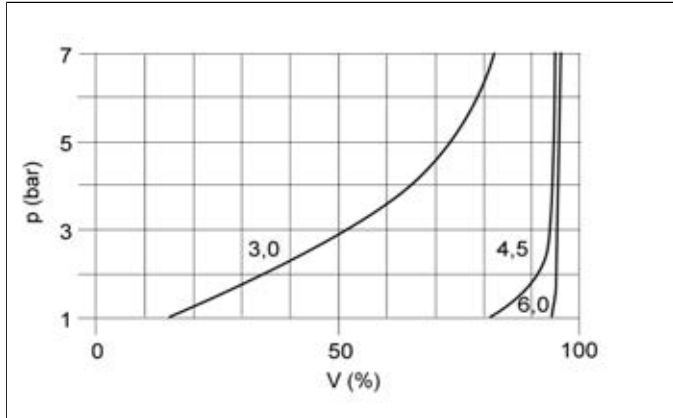

### Maximum vacuum achieved for water-jet pumps SP 820, DN 25

nozzle bore: 2,5; 4,0; 5,0

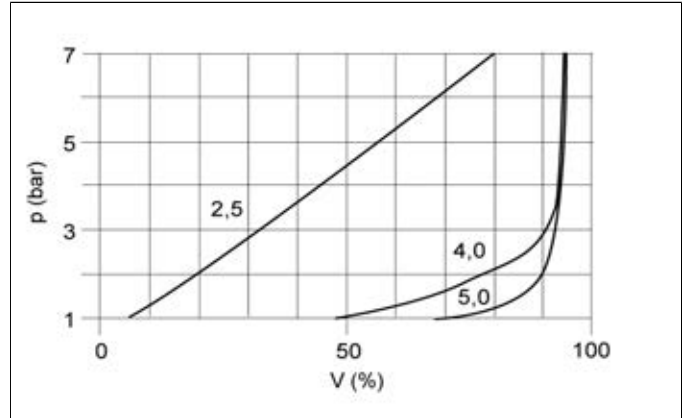

### Maximum vacuum achieved for water-jet pumps SP 820, DN 32

nozzle bore: 3,0; 4,5; 6,0

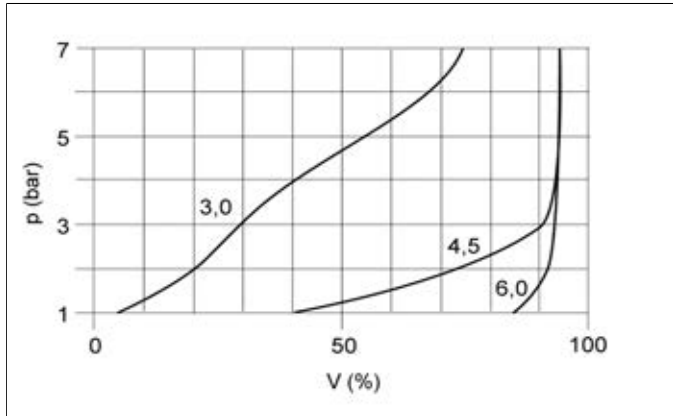

### Maximum vacuum achieved for water-jet pumps SP 820, DN 40

nozzle bore: 3,5; 5,5; 7,5

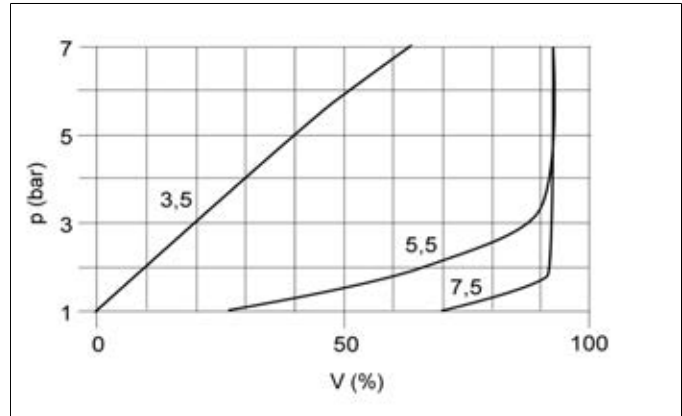

### Maximum vacuum achieved for water-jet pumps SP 820, DN 50

nozzle bore: 5,0; 7,0; 9,0

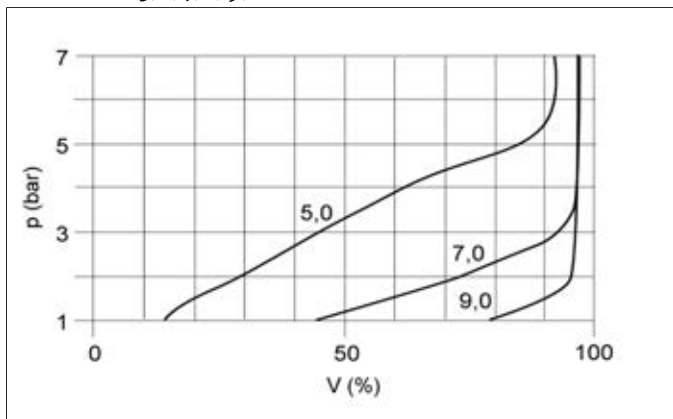

### Maximum vacuum achieved for water-jet pumps SP 820, DN 65

nozzle bore: 6,5; 9,0; 11,5

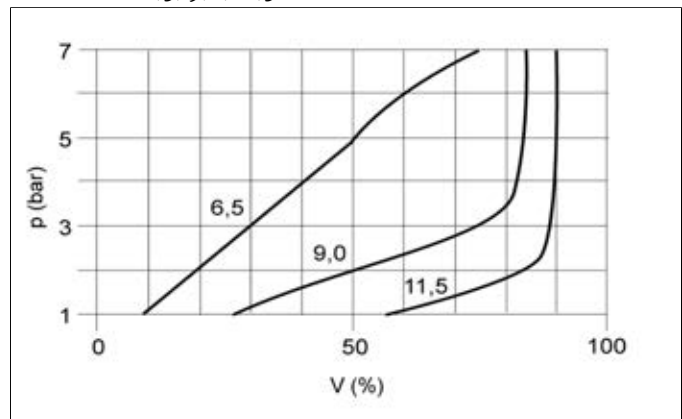

$p$  = propulsion water pressure (bar)  
 $V$  = vacuum (%)

$p$  = propulsion water pressure (bar)  
 $V$  = vacuum (%)



## Water-jet pump SP 820

### Maximum vacuum achieved for water-jet pumps SP 820, DN 80

nozzle bore: 8,0; 11,0; 14,0

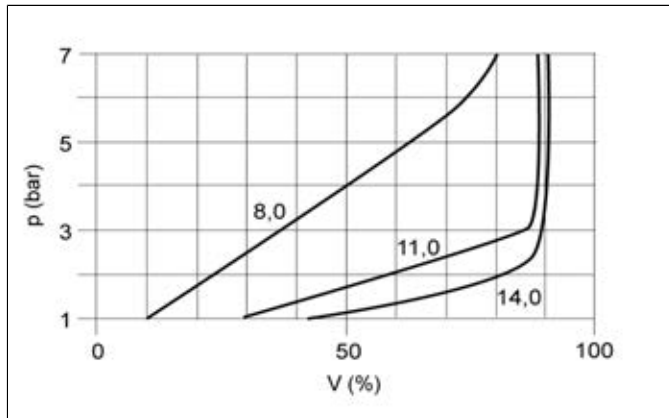

$p$  = propulsion water pressure (bar)

$V$  = vacuum (%)

## Water-jet pump SP 820